

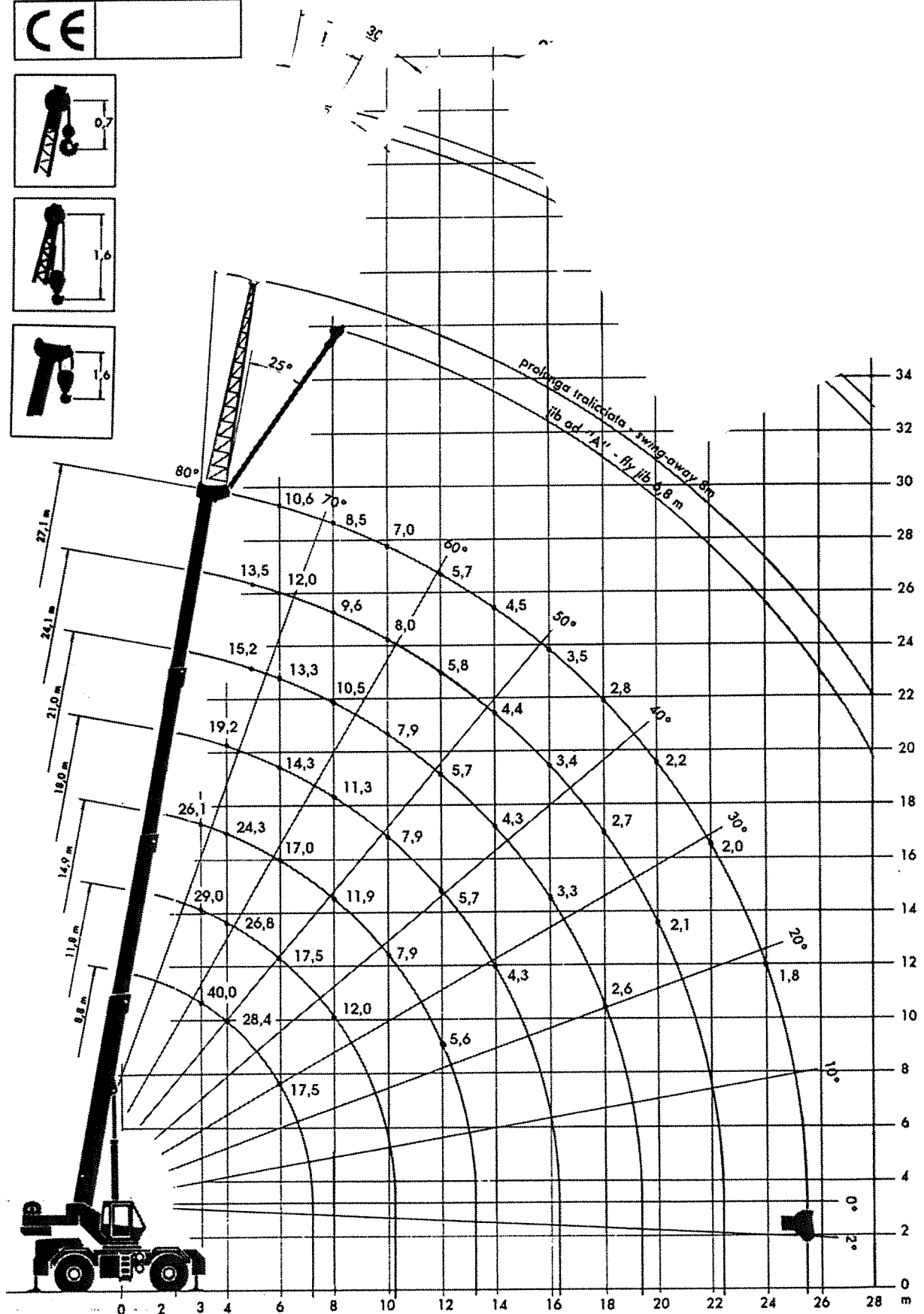

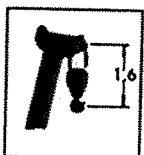

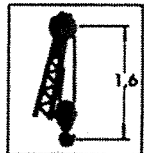

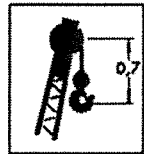

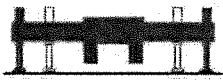

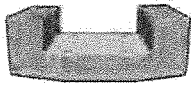



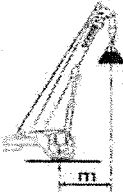



Capacità di sollevamento, altezze e raggio  
 Lifting capacities, heights and radius  
 Charges, hauteurs et portées  
 Traglasten / Hubhöhen







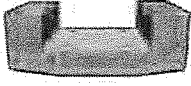



				
5.80 m	27.10 m	5.70 t	360°	8.0 m / 14 m

						
	27.10m + 8.0m	27.10m + 8.0m	27.10m + 8.0m	27.10m + 14.0m	27.10m + 14.0m	
	0°	0°	20°	0°	20°	
						
8.0	5.00	5.00				8.0
9.0	4.70	4.70	2.50	2.40		9.0
10.0	4.40	4.40	2.40	2.20		10.0
12.0	3.80	3.80	2.20	2.00	1.10	12.0
14.0	3.20	3.20	2.10	1.80	1.05	14.0
16.0	2.80	2.80	2.00	1.60	1.00	16.0
18.0	2.50	2.50	1.90	1.40	0.95	18.0
20.0	2.20	2.20	1.80	1.30	0.90	20.0
22.0	2.00	2.00	1.70	1.20	0.85	22.0
24.0	1.70	1.70	1.60	1.10	0.80	24.0
26.0	1.40	1.40	1.50	1.00	0.75	26.0
28.0	1.20	1.20	1.40	0.90	0.70	28.0
30.0						30.0

				
5.80 m	27.10 m	5.70 t	360°	6.8m / 8.0m + 6.8m

						
	27.10m + 6.8m	27.10m + 6.8m	27.10m + 8.0m + 6.8m	27.10m + 8.0m + 6.8m	27.10m + 8.0m + 6.8m	
	10°	25°	3°	16°	30°	
						
8.0	4.00					8.0
10.0	3.60	2.70	2.60	1.90		10.0
12.0	3.30	2.50	2.30	1.80	1.40	12.0
16.0	2.80	2.20	1.80	1.50	1.20	16.0
20.0	2.30	1.90	1.40	1.20	1.10	20.0
24.0	1.70	1.60	1.20	1.10	1.00	24.0
28.0	1.20	1.20	1.10	1.00	0.90	28.0
30.0						30.0

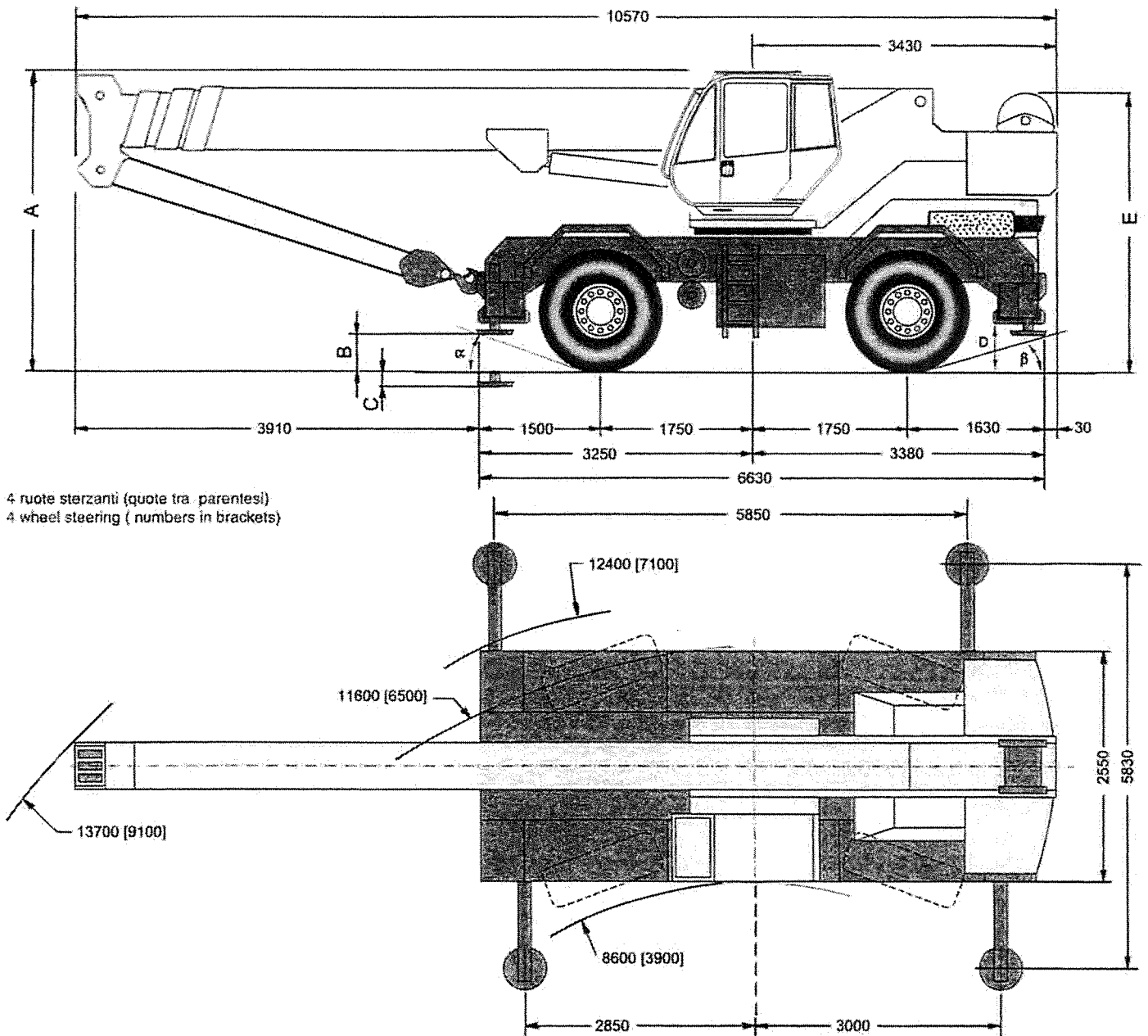

Dimensioni / Dimensions / Dimensions / Abmessungen <sup>(4)</sup>							
Pneumatici / Tyres Pneumatiques / Reifen	A	E	C	B	D	$\alpha$	$\beta$
16.00R25	3450	3300	190	360	410	21°	20°
20.5R25	3445	3295	195	355	405	21°	20°

(4) Dimensioni medie di riferimento fornite a puro titolo indicativo. Valori espressi in millimetri  
 (4) Average reference values, which are indicative only. Values are expressed in mm  
 (4) Dimensions moyennes de référence fournies à titre purement indicatif. Valeurs exprimées en millimètres  
 (4) Durchschnittsmaße, dienen ausschließlich als Richtwerte. Die Werte sind in Millimetern ausgedrückt

Note	Notes	Notes	Hinweise
Tutte le caratteristiche e le specifiche descritte possono essere soggette a variazioni senza preavviso. Tutti i dati riportati sono forniti a puro titolo informativo e non sono impegnativi dal momento che le prestazioni della macchina variano in funzione dell'utilizzo. La sola garanzia applicabile è quella fornita da TEREX Italia per i propri prodotti.	All specifications and features herein described can be changed without prior advice. All indicated data are indicative only and are not binding as crane performs differently depending on its use. Only the warranty terms granted by TEREX Italia for their products can be applied.	Toutes les caractéristiques et spécifications décrites peuvent être sujettes à variations sans préavis. Toutes les données indiquées sont fournies à titre purement indicatif et n'engage pas la responsabilité du fabricant dans la mesure où les performances de la machine varient en fonction de l'utilisation. La seule garantie applicable est celle fournie par TEREX Italia pour ses propres produits.	Unangekündigte Änderungen sämtlicher Eigenschaften und Daten sind möglich. Alle Angaben sind Richtwerte und nicht verbindlich, da die Leistungen der Vorrichtung von deren Einsatz abhängen. Die einzige gültige Garantie ist jene der Firma TEREX Italia für die von dieser hergestellten Produkte.